

Family 12

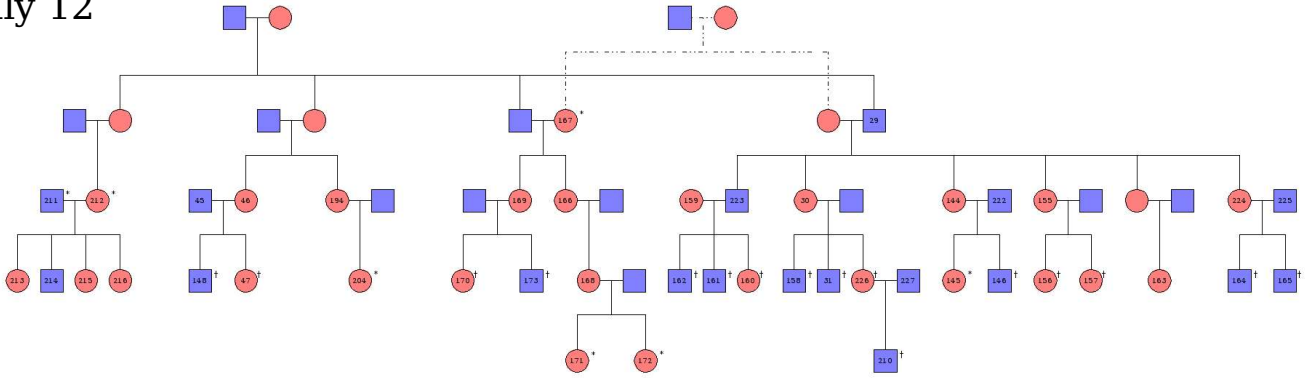

Family 13

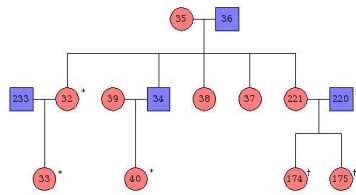

Family 21

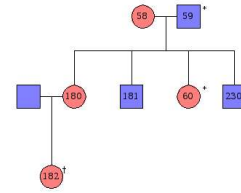

Family 39

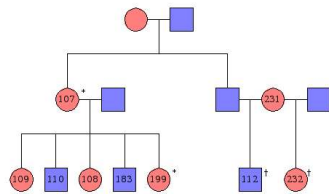

Family 48

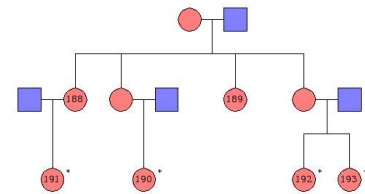

Family 49

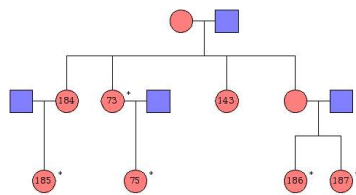

Family 50

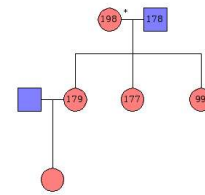

Family 51

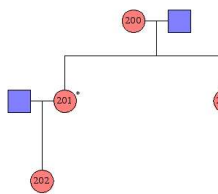

Family 52

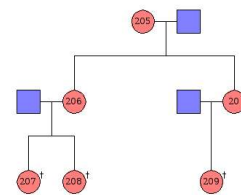

**Supplementary Figure 1:** Pedigrees of individuals in the Ogies study population. Sampled individuals are represented by numerals from 29-233. \* are individuals for which biopsies were performed, yet for which sequence data are unavailable due to a lack of *H. pylori* infection. † are offspring for which transmission was simulated in the model.